



40 dB Fixed Attenuator, SMA Male To SMA Female Directional
Black Aluminum Heatsink Body Rated To 300 Watts Up To 3 GHz

TECHNICAL DATA SHEET

PE7406-40

Pasternack Enterprises' line of 300W Attenuators operate from DC to 3 GHz, and are available in 16 different 7/16 DIN, N, SMA and TNC in-series combinations. Our 300W Attenuators are manufactured with Passivated Stainless Steel SMA, TNC and N connectors, and Silver Plated Brass 7/16 DIN connectors. Pasternack 300W Attenuators come in 3 dB, 6 dB, 10 dB, 20 dB, 30 dB, 40 dB, & 50 dB values and will operate from -55 to +125 degrees C. Additional between-series connector combinations are available upon request.

- 300W average power and 2,500W peak power handling capability
- Operates to 3 GHz
- Temperature range of -55 to +125 degrees C
- 16 in-series combinations
- 7/16 DIN, SMA, N, TNC Male and Female connectors are available
- Other connector combinations available upon request

Configuration

Design	Fixed, Directional Attenuator
Connector 1	SMA Male
Connector 2	SMA Female
Body Material and Plating	Black Aluminum Heatsink

Electrical Specifications * Values at 25°C, sea level

Description	Minimum	Typical	Maximum	Units
Frequency Range	DC		3	GHz
Impedance		50		Ohms
Attenuation Value		40		dB
Accuracy Statement	Attenuation accuracy it + / -			
Input Power			300	Watts
Peak Power			2.5	KWatts
VSWR			1.4:1	

Specifications by Frequency

Description	F1	F2	F3	F4	F5	Units
Range	DC to 1.5	1.5 to 3				GHz
VSWR	1.2:1	1.4:1				
Attenuation Accuracy	± 1	± 1.25				dB

Mechanical Specifications

Temperature	
Operating Range	-55 to +125 deg C

Click the following link (or enter part number in "SEARCH" on website) to obtain additional part information including price, inventory and certifications: [40 dB Fixed Attenuator, SMA Male To SMA Female Directional Black Aluminum Heatsink Body Rated To 300 Watts Up To 3 GHz PE7406-40](#)



40 dB Fixed Attenuator, SMA Male To SMA Female Directional
Black Aluminum Heatsink Body Rated To 300 Watts Up To 3 GHz

TECHNICAL DATA SHEET

PE7406-40

Size

Length	5.6 in [142.24 mm]
Width	6.2 in [157.48 mm]
Height	6.3 in [160.02 mm]
Weight	4 lbs [1.81 Kg]

Connectors

Description	Connector 1	Connector 2
Type	SMA Male	SMA Female
Contact Material and Plating	Beryllium Copper, Gold	Beryllium Copper, Gold
Outer Conductor Material and Plating		Passivated Stainless Steel
Coupling Nut Material and Plating	Passivated Stainless Steel	
Body Material and Plating	Passivated Stainless Steel	Passivated Stainless Steel

Compliance Certifications (visit www.Pasternack.com for current document)
RoHS Compliant

Plotted and Other Data

Notes:

- Values at 25 °C, sea level
- Calculated Heatsink Thermal Rise: .7C / Watt

Click the following link (or enter part number in "SEARCH" on website) to obtain additional part information including price, inventory and certifications: [40 dB Fixed Attenuator, SMA Male To SMA Female Directional Black Aluminum Heatsink Body Rated To 300 Watts Up To 3 GHz PE7406-40](#)



40 dB Fixed Attenuator, SMA Male To SMA Female Directional
Black Aluminum Heatsink Body Rated To 300 Watts Up To 3 GHz

TECHNICAL DATA SHEET

PE7406-40

Outline Drawing

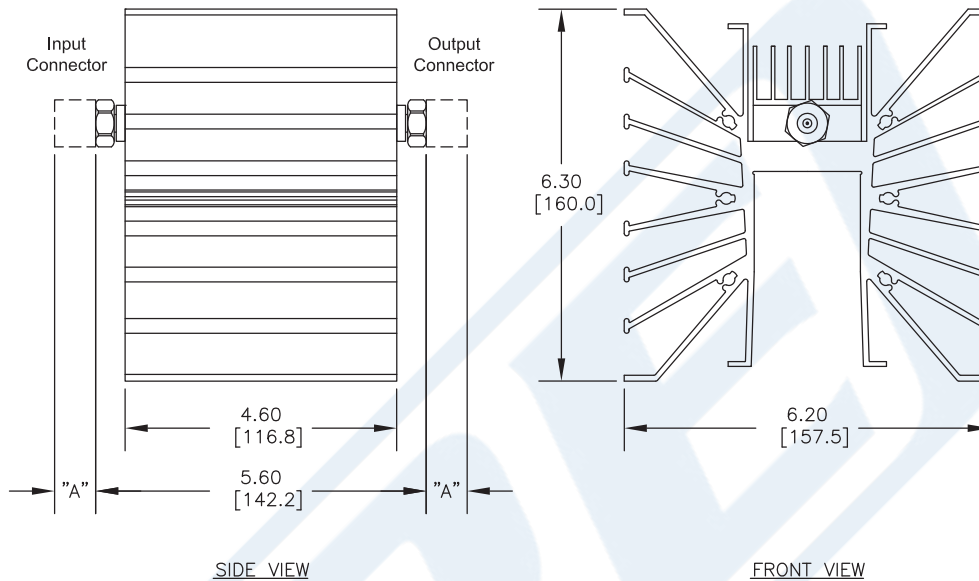

Part Number Configuration		
xx	Input Connector	Output Connector
05	SMA Male	SMA Male
06	SMA Male	SMA Female
07	SMA Female	SMA Female
08	SMA Female	SMA Male
09	N Male	N Male
10	N Male	N Female
11	N Female	N Female
12	N Female	N Male
13	TNC Male	TNC Male
14	TNC Male	TNC Female
15	TNC Female	TNC Female
16	TNC Female	TNC Male
17	7/16 Male	7/16 Male
18	7/16 Male	7/16 Female
19	7/16 Female	7/16 Female
20	7/16 Female	7/16 Male
-yy	Indicates Attenuation Level	

Table of Information		
Connector Type	Dim "A" (Ref.)	
SMA Male	0.88	
SMA Female	0.73	
TNC Male	1.06	
TNC Female	1.16	
N Female	1.19	
N Male	1.23	
7/16 Male	1.38	
7/16 Female	1.42	

40 dB Fixed Attenuator, SMA Male To SMA Female Directional Black Aluminum Heatsink Body Rated To 300 Watts Up To 3 GHz from Pasternack Enterprises has same day shipment for domestic and International orders. Our RF, microwave and millimeter wave products maintain a 99% availability and are part of the broadest selection in the industry.

Click the following link (or enter part number in "SEARCH" on website) to obtain additional part information including price, inventory and certifications: [40 dB Fixed Attenuator, SMA Male To SMA Female Directional Black Aluminum Heatsink Body Rated To 300 Watts Up To 3 GHz PE7406-40](http://www.pasternack.com/40db-fixed-sma-male-sma-female-300-watts-attenuator-pe7406-40-p.aspx)

URL: <http://www.pasternack.com/40db-fixed-sma-male-sma-female-300-watts-attenuator-pe7406-40-p.aspx>