



23 dBm P1dB, 18 GHz to 40 GHz, Medium Power Amplifier, 2.92mm, 35 dB Gain, 9 dB NF

## TECHNICAL DATA SHEET

PE15A4065

The PE15A4065 is a medium power amplifier, operating from 18 to 40 GHz and designed for use in a wide range of general purpose applications. Typical performance includes 23 dBm of output P1dB min. and 35 dB small signal gain. This power amplifier requires a +12V DC supply, is unconditionally stable, and operates over the temperature range of 0°C to 50°C. The thin film assembly features rugged stripline construction with select GaAs FET devices. The package supports field replaceable 2.92mm connectors and is designed for high reliability meeting MIL-STD-202 environmental test conditions for Humidity, Shock, Vibration, and altitude.

### Features

- 18 to 40 GHz Frequency Range
- P1dB 23 dBm min.
- Small Signal Gain: 35 dB min.
- Gain Flatness:  $\pm 4$  dB max.
- 50 Ohm Input and Output Matched
- 0 to 50°C Operating Temperature
- Unconditionally Stable
- Single DC Positive Supply
- Built-in DC Voltage Regulator
- Field Replaceable 2.92mm Female connectors

### Applications

- Electronic Warfare
- Electronic Countermeasures
- Radar Systems
- Telecom Infrastructure
- Test Instrumentation
- Communication Systems
- Satellite Communications
- Microwave Radio Systems
- Driver Amplifier
- High Power Output Amplifier

**Electrical Specifications** (TA = +25°C, DC Voltage = 12Volts, DC Current = 1A)

Description	Minimum	Typical	Maximum	Units
Frequency Range	18		40	GHz
Small Signal Gain	35			dB
Gain Flatness			$\pm 4$	dB
Output Power at 1 dB Compression Point	+23			dBm
Noise Figure			9	dB
Impedance (Input)		50		Ohms
Impedance (Output)		50		Ohms
Input VSWR		2.5:1		
Output VSWR		2.5:1		
Operating DC Voltage		12		Volts
Operating DC Current		1		A
Operating Temperature Range	0		+50	°C

Click the following link (or enter part number in "SEARCH" on website) to obtain additional part information including price, inventory and certifications: [23 dBm P1dB, 18 GHz to 40 GHz, Medium Power Amplifier, 2.92mm, 35 dB Gain, 9 dB NF PE15A4065](#)



23 dBm P1dB, 18 GHz to 40 GHz, Medium Power  
Amplifier, 2.92mm, 35 dB Gain, 9 dB NF

## TECHNICAL DATA SHEET

PE15A4065

### Mechanical Specifications

#### Size

Length	1.05 in [26.67 mm]
Width	1.48 in [37.59 mm]
Height	0.35 in [8.89 mm]
Input Connector	2.92mm Female
Output Connector	2.92mm Female
Bias Connector	Solder Pin

### Environmental Specifications

#### Temperature

Operating Range	0 to +50 deg C
Storage Range	-40 to +100 deg C

#### Humidity

Shock	MIL-STD-202F, Method 103B, Condition B
Vibration	MIL-STD-202F, Method 213B, Condition B
Altitude	MIL-STD-202F, Method 204D, Condition B
	MIL-STD-202F, Method 105C, Condition B

### Compliance Certifications (see [product page](#) for current document)

### Plotted and Other Data

#### Notes:

- Values at +25 °C, sea level
- The following precautions for the PE15A4065 must be noted:
  1. Max Pin = 0 dBm
  2. DC Bias @ RF input may damage the amplifier
  3. Heat Sink Required for Proper Operation

Click the following link (or enter part number in "SEARCH" on website) to obtain additional part information including price, inventory and certifications: [23 dBm P1dB, 18 GHz to 40 GHz, Medium Power Amplifier, 2.92mm, 35 dB Gain, 9 dB NF PE15A4065](#)



23 dBm P1dB, 18 GHz to 40 GHz, Medium Power  
Amplifier, 2.92mm, 35 dB Gain, 9 dB NF

TECHNICAL DATA SHEET

PE15A4065

**Amplifier Power-up Precautions**

- 1.) Confirm that proper ESD precautions and controls are always in place before handling any Amplifier module.
- 2.) Confirm adequate thermal management is in place to effectively dissipate heat away from the Amplifier package. The Amplifier operational baseplate temperature must be within the operational temperature range stated in the Amplifier datasheet. Depending on the design and thermal requirements, using a heatsink with cooling fan is always recommended for safe reliable operation. A heat sink without a cooling fan may also be used. Damage caused from overheating will void the warranty.
- 3.) Confirm adequate system grounding is established. The DC power supply and Amplifier must have a common ground in order to operate properly.
- 4.) Power Amplifiers may require additional DC Current when initially powered-up. Depending on the design, the input current draw could range from an additional 10% to 100% above the maximum rated DC current of the Amplifier. This varies based on product part number.
- 5.) Confirm the DC power supply, if limited, is set to allow for additional start-up current that's rated for the Power Amplifier.
- 6.) Confirm the system is designed and calibrated for 50 ohms. Any impedance mismatch may cause performance issues.
- 7.) Perform a CALIBRATION (if required) with the loads before connecting the Amplifier to the Network Analyzer to ensure proper performance.
- 8.) Use a fixed attenuator between the signal source and input port of the Amplifier to optimize the input VSWR match.
- 9.) Confirm the input power level at the input port of the amplifier does not exceed the maximum rated limit for input power (as stated in the Amplifier datasheet).  
 $P_{in}$  for Small Signal Gain = P1dB-SSG-10 dB  
 $P_{in}$  for P1dB = P1dB-SSG+1 dB
- 10.) Confirm the Network Analyzer is always connected to the Amplifier first before DC power is applied to the Amplifier.
- 11.) As long as the input and output ports of the amplifier are connected to a 50Ohm load and RF signal power is applied, the Amplifier can be powered up with DC voltage.
- 12.) Confirm the Amplifier output load is matched for a 50 Ohm impedance and will not exceed the maximum rated VSWR or Return Loss limit for the Amplifier. Exceeding the maximum rated VSWR or Return Loss limit will result in reflected signal power that could damage the Amplifier and void the warranty.
- 13.) **Power Amplifier connected to an Antenna for signal transmission** - It's strongly recommended to use a high power fixed attenuator pad or an Isolator between the output port of the Amplifier and input port to the antenna. Any reflected signal power due to impedance mismatch will likely damage the Amplifier and void the warranty.
- 14.) The attenuator or isolator used at the output port of the Amplifier must be rated to handle the output power level and operational frequency band of the amplifier.

Click the following link (or enter part number in "SEARCH" on website) to obtain additional part information including price, inventory and certifications: [23 dBm P1dB, 18 GHz to 40 GHz, Medium Power Amplifier, 2.92mm, 35 dB Gain, 9 dB NF PE15A4065](#)



23 dBm P1dB, 18 GHz to 40 GHz, Medium Power  
Amplifier, 2.92mm, 35 dB Gain, 9 dB NF

TECHNICAL DATA SHEET

PE15A4065

Typical Performance Data

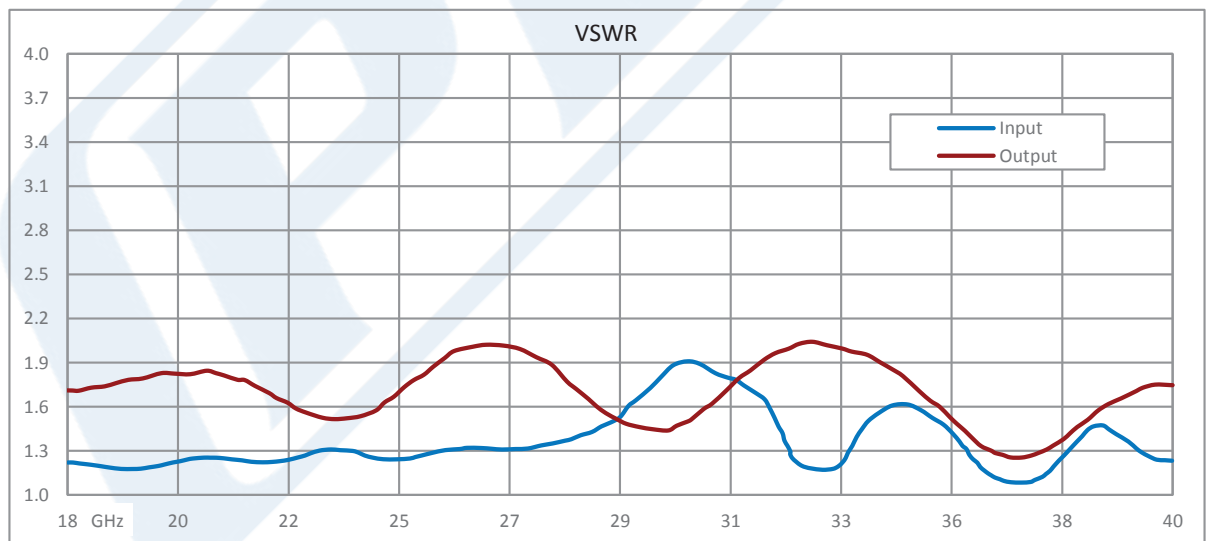
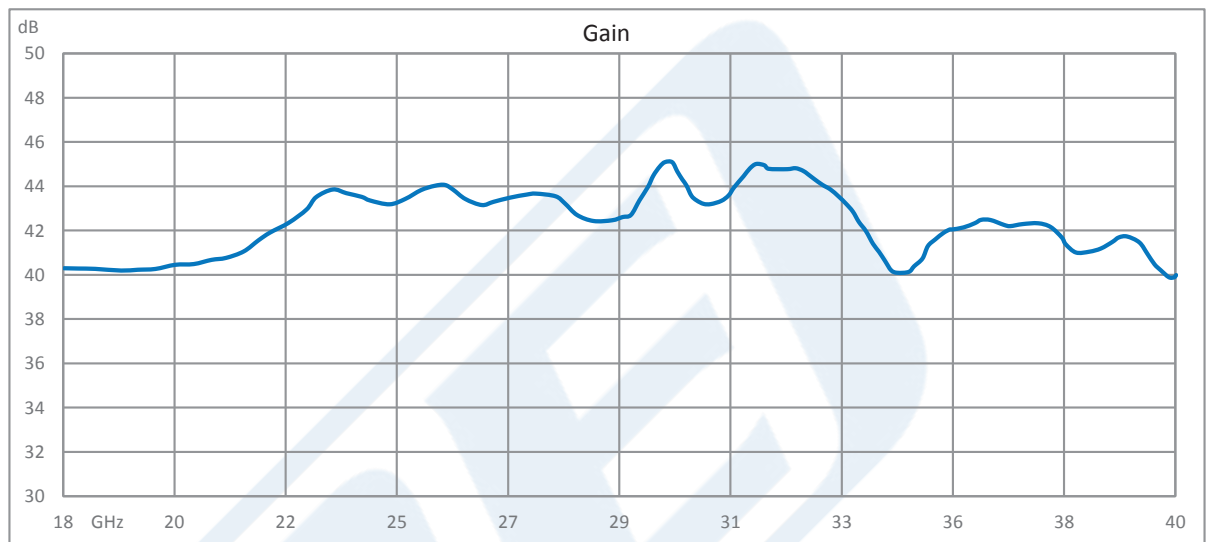

Click the following link (or enter part number in "SEARCH" on website) to obtain additional part information including price, inventory and certifications: [23 dBm P1dB, 18 GHz to 40 GHz, Medium Power Amplifier, 2.92mm, 35 dB Gain, 9 dB NF PE15A4065](#)



23 dBm P1dB, 18 GHz to 40 GHz, Medium Power  
Amplifier, 2.92mm, 35 dB Gain, 9 dB NF

TECHNICAL DATA SHEET

PE15A4065

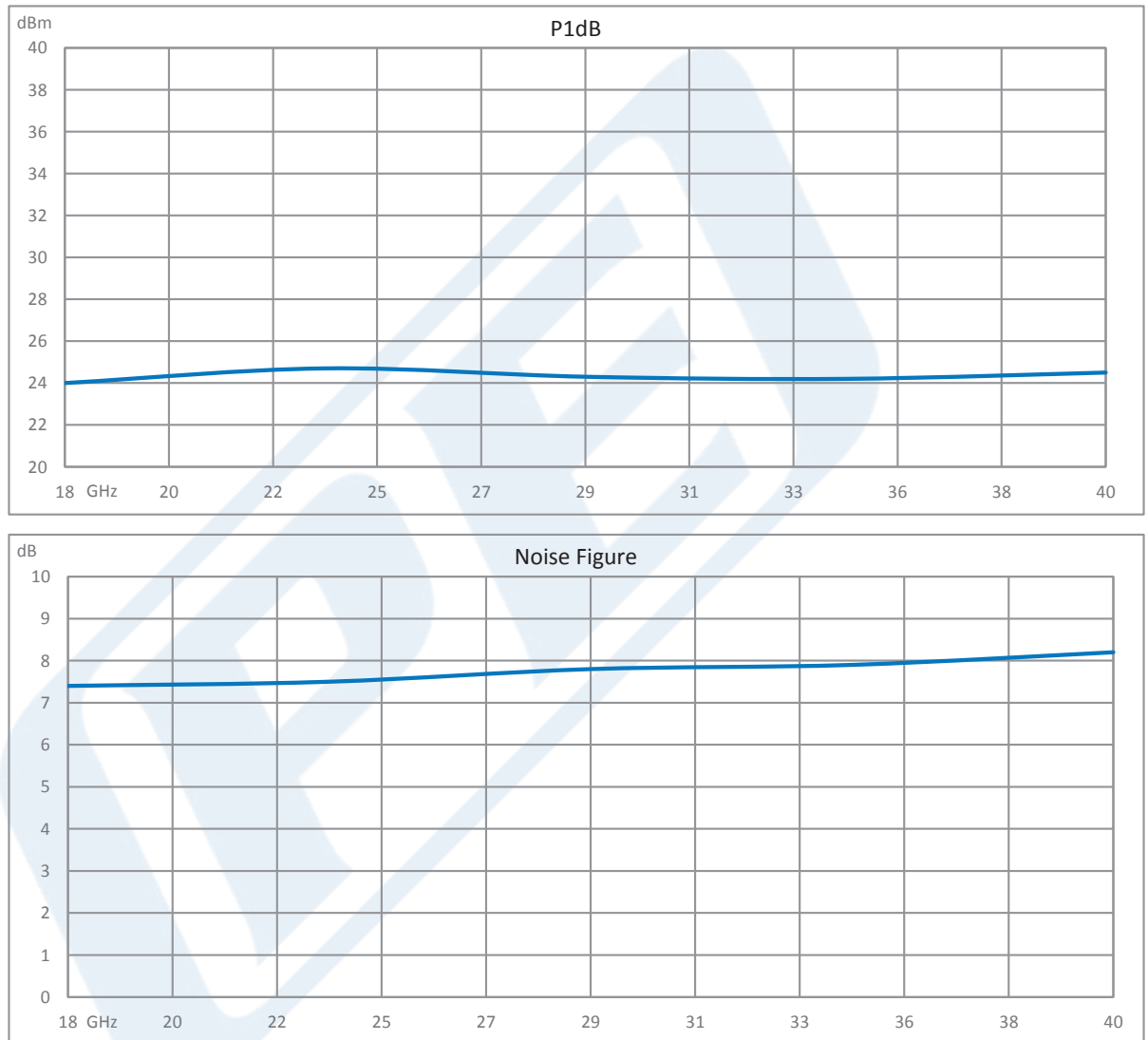

Click the following link (or enter part number in "SEARCH" on website) to obtain additional part information including price, inventory and certifications: [23 dBm P1dB, 18 GHz to 40 GHz, Medium Power Amplifier, 2.92mm, 35 dB Gain, 9 dB NF PE15A4065](#)



23 dBm P1dB, 18 GHz to 40 GHz, Medium Power  
Amplifier, 2.92mm, 35 dB Gain, 9 dB NF

TECHNICAL DATA SHEET

PE15A4065

23 dBm P1dB, 18 GHz to 40 GHz, Medium Power Amplifier, 2.92mm, 35 dB Gain, 9 dB NF from Pasternack Enterprises has same day shipment for domestic and International orders. Our RF, microwave and millimeter wave products maintain a 99.4% availability and are part of the broadest selection in the industry.

Click the following link (or enter part number in "SEARCH" on website) to obtain additional part information including price, inventory and certifications: [23 dBm P1dB, 18 GHz to 40 GHz, Medium Power Amplifier, 2.92mm, 35 dB Gain, 9 dB NF PE15A4065](https://www.pasternack.com/40-ghz-medium-power-amplifier-35-db-gain-2.92mm-pe15a4065-p.aspx)

URL: <https://www.pasternack.com/40-ghz-medium-power-amplifier-35-db-gain-2.92mm-pe15a4065-p.aspx>

The information contained in this document is accurate to the best of our knowledge and representative of the part described herein. It may be necessary to make modifications to the part and/or the documentation of the part, in order to implement improvements. Pasternack reserves the right to make such changes as required. Unless otherwise stated, all specifications are nominal. Pasternack does not make any representation or warranty regarding the suitability of the part described herein for any particular purpose, and Pasternack does not assume any liability arising out of the use of any part or documentation.

# PE15A4065 CAD Drawing

23 dBm P1dB, 18 GHz to 40 GHz, Medium Power Amplifier, 2.92mm, 35 dB Gain, 9 dB NF

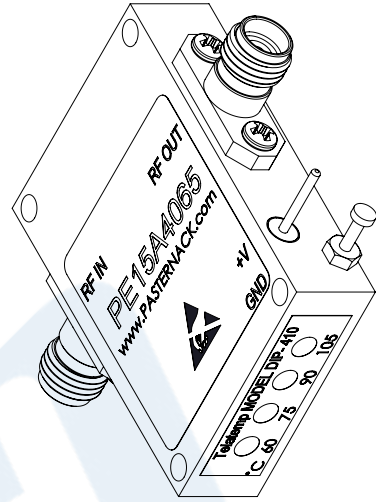
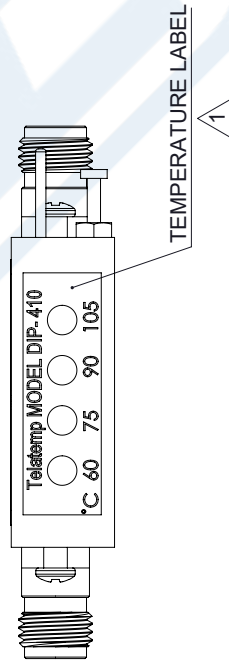
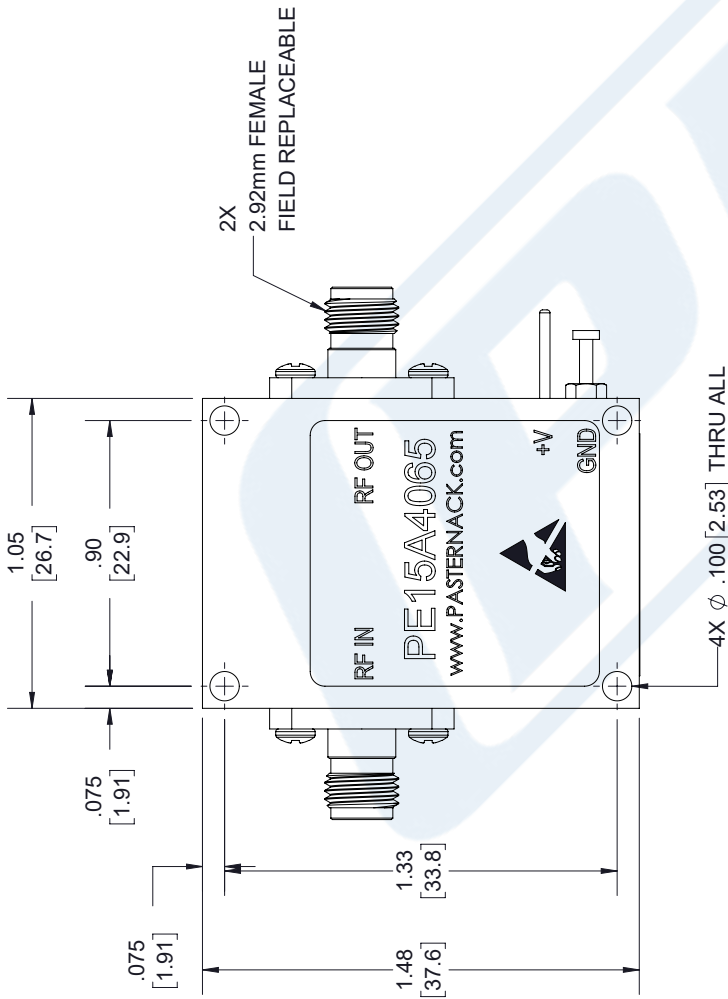
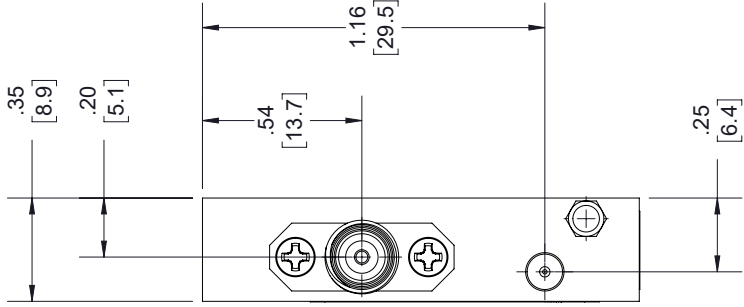

NOTE:  
1. WARRANTY VOID IF REMOVED.

STANDARD TOLERANCES	
.X	±0.2
.XX	±0.01
.XXX	±0.005

\*STANDARD TOLERANCES APPLY ONLY TO DIMENSIONS IN INCHES

**PE PASTERNAK®**  
THE ENGINEER'S RF SOURCE  
Pasternack Enterprises, Inc.  
P.O. Box 16759 | Irvine | CA | 92623  
Phone: (949) 261-1920 | Fax: (949) 261-7451  
Website: www.pasternack.com | E-Mail: sales@pasternack.com

DWG TITLE	PE15A4065
CAGE CODE	53919

NOTES:	1. UNLESS OTHERWISE SPECIFIED ALL DIMENSIONS ARE NOMINAL. 2. ALL SPECIFICATIONS ARE SUBJECT TO CHANGE WITHOUT NOTICE AT ANY TIME. 3. DIMENSIONS ARE IN INCHES [mm].
CAD FILE	05/15/18
SCALE	N/A
SIZE	A
	7361