



4 dB Fixed Attenuator, N Male to N Female Passivated Stainless Steel Body Rated to 2 Watts Up to 18 GHz

RF Fixed Attenuators Technical Data Sheet

PE7004-4

Features

- Bidirectional
- DC to 18 GHz Frequency Range
- Attenuation 4±0.3 dB
- Max Power 2 Watts (CW)
- VSWR < 1.35:1

Applications

- Instrumentation
- Precision measurements
- Prototyping and characterization
- Production systems

Description

Pasternack carries a wide range of fixed attenuators with a broad selection of attenuation levels, frequency ranges, and power dissipation ranges. RF microwave attenuators (also known as RF pads) lower the amplitude of a signal (attenuate) a known amount and can be used in a wide variety of applications. These attenuator pads are used when a signal needs to be reduced to protect measurement equipment or other circuitry, to extend the range of power meters and amplifiers, and to impedance match circuits by reducing the VSWR seen by adjacent components. RF attenuators can prevent signal overload in amplifiers, receivers and detectors, adjusting the signal level to a range that is optimal.

Few RF components are as commonly used as fixed coaxial attenuators, and Pasternack carries one of the largest in-stock varieties and ships them same day. The 4 dB Fixed Attenuator PE7004-4 is rated to 2 Watts and operates from DC to 18 GHz. The versatile coaxial package uses type N male to type N female connectors and is also REACH and RoHS compliant.

Electrical Specifications

Description	Minimum	Typical	Maximum	Units
Frequency Range	DC		18	GHz
Impedance		50		Ohms
Nominal Attenuation		4		dB
Attenuation Accuracy		0.3		dB
VSWR			1.35:1	
Input Power, CW derated linearly from 2W @ 25°C to 0.5W @ 125°C			2	Watts
Input Power, Peak 5µs pulse, 0.05% duty cycle			250	Watts

Click the following link (or enter part number in "SEARCH" on website) to obtain additional part information including price, inventory and certifications: [4 dB Fixed Attenuator, N Male to N Female Passivated Stainless Steel Body Rated to 2 Watts Up to 18 GHz PE7004-4](#)



4 dB Fixed Attenuator, N Male to N Female Passivated
Stainless Steel Body Rated to 2 Watts Up to 18 GHz

RF Fixed Attenuators Technical Data Sheet

PE7004-4

Specifications by Frequency

Description	F1	F2	F3	F4	F5	Units
Range	DC to 4	4 to 8	8 to 12.4	12.4 to 18		GHz
VSWR, Max	1.15:1	1.2:1	1.25:1	1.35:1		

Mechanical Specifications

Size

Length	1.76 in [44.7 mm]
Width/Diameter	0.83 in [21.08 mm]
Weight	0.1355 lbs [61.46 g]
Body Material and Plating	Passivated Stainless Steel

Configuration

Design	Fixed, Bidirectional
Package Style	Connectorized Module

Connectors

Description	Connector 1	Connector 2
Type	N Male	N Female
Connector Specification	MIL-STD-348	MIL-STD-348
Contact Material and Plating	Beryllium Copper, Gold	Beryllium Copper, Gold
Body Material and Plating	Passivated Stainless Steel	Passivated Stainless Steel

Environmental Specifications

Temperature

Operating Range	-65 to +125 deg C
-----------------	-------------------

Compliance Certifications (see [product page](#) for current document)

Plotted and Other Data

Notes:

Click the following link (or enter part number in "SEARCH" on website) to obtain additional part information including price, inventory and certifications: [4 dB Fixed Attenuator, N Male to N Female Passivated Stainless Steel Body Rated to 2 Watts Up to 18 GHz PE7004-4](#)



4 dB Fixed Attenuator, N Male to N Female Passivated
Stainless Steel Body Rated to 2 Watts Up to 18 GHz

RF Fixed Attenuators Technical Data Sheet

PE7004-4

4 dB Fixed Attenuator, N Male to N Female Passivated Stainless Steel Body Rated to 2 Watts Up to 18 GHz from Pasternack Enterprises has same day shipment for domestic and International orders. Our RF, microwave and millimeter wave products maintain a 99.4% availability and are part of the broadest selection in the industry.

Click the following link (or enter part number in "SEARCH" on website) to obtain additional part information including price, inventory and certifications: [4 dB Fixed Attenuator, N Male to N Female Passivated Stainless Steel Body Rated to 2 Watts Up to 18 GHz PE7004-4](https://www.pasternack.com/4db-fixed-n-female-n-male-2-watts-attenuator-pe7004-4-p.aspx)

URL: <https://www.pasternack.com/4db-fixed-n-female-n-male-2-watts-attenuator-pe7004-4-p.aspx>

PE7004-4 CAD Drawing

4 dB Fixed Attenuator, N Male to N Female Passivated
Stainless Steel Body Rated to 2 Watts Up to 18 GHz

REVISIONS		
REV.	DESCRIPTION	DATE
A	PCR PE7004	9/17/2020
		APPROVED
		S. ELLIS

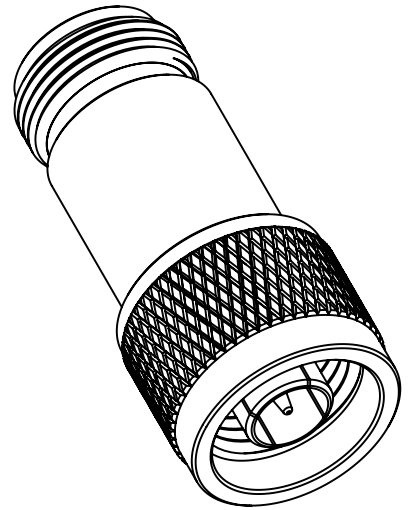
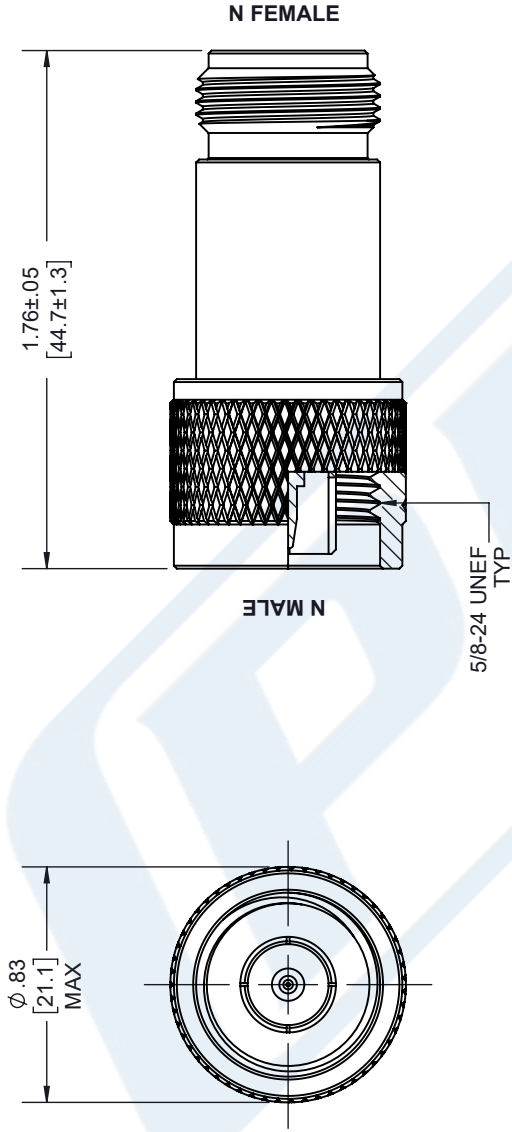

UNLESS OTHERWISE SPECIFIED
LEADING DIMENSIONS ARE INCHES
DIMENSIONS IN [] ARE MILLIMETERS

TOLERANCES:
 .X = ± .2 [.008] FRACTIONS ± 1/32
 .XX = ± .02 [.51] ANGLES ± 1°
 .XXX = ± .005 [.13]

CABLE LENGTH (L), TOLERANCES:
 L ≤ 12 [305] = +1 [25] / -0
 12 [305] < L ≤ 60 [1524] = +2 [51] / -0
 60 [1524] < L ≤ 120 [3048] = +4 [102] / -0
 120 [3048] < L ≤ 300 [7620] = +6 [152] / -0
 300 [7620] < L = +5% / -0

ALL DIMENSIONS SHOWN
ARE FOR REFERENCE ONLY.

PE PASTERNAK
an INFINITE brand

Pasternack Enterprises, Inc.
P. O. Box 16759, Irvine, CA 92623.
Phone: 1.949.261.1920 | 1.866.727.8376
Fax: 1.949.261.7451
Website: www.pasternack.com
E-mail: sales@pasternack.com

SIZE A CAGE CODE 53919 DRAWN BY K.DANG ITEM NO. PE7004-4

THIRD-ANGLE PROJECTION

THE INFORMATION AND DESIGN IN THIS DOCUMENT IS THE PROPERTY OF PASTERNAK CORPORATION ALL RIGHTS RESERVED.

SHEET 1 OF 1

SCALE N/A

REV A